

We pioneer motion

Rolling Bearings and Services for Mining and Raw Materials Processing



The right solution for every bearing position

As one of the world's largest rolling bearing manufacturers, Schaeffler is a partner for all leading manufacturers and operators in the mining and raw materials processing industry. Our bearing solutions and services increase the functional safety and performance capacity of machinery and processes. Our expert technical consultation services and extensive global distribution network enable us to help lower our partners' overall costs.



Contents

Everything from a single source	4 – 5
Overview of Schaeffler's product range:	
The right bearings and services for every application	
<hr/>	
Mining	6 – 9
Tunnel boring machine, bucket wheel excavator and shaft boring machine: bearings and services	
<hr/>	
Loading	10 – 11
Energy-saving solutions for dragline and cable excavators + troubleshooting package	
<hr/>	
Transporting/conveying	12 – 14
Products for dump trucks and belt conveyors + savings tip: split spherical roller bearings	
<hr/>	
Crushing	16 – 19
Bearing innovations for crushers, vertical mills, roller presses, tube mills + special service	
<hr/>	
Screening	20 – 21
Vibratory screen bearings with special coating for significantly longer service life	
<hr/>	
Processing	22 – 23
Rotary kilns as application area for complete bearing units, bearings for pelleting plants + Arcanol	
<hr/>	
Electric motor & pump	24
Low-friction and low-noise ball bearings with energy-saving potential + innovative seals	
<hr/>	
Sales & service	25
Sales partner approach ensures fast, responsive assistance + special service: grease analysis	
<hr/>	
Lifetime Solutions	
Condition monitoring systems	26 – 27
Lubrication	19 + 23
Mounting services and maintenance tools	28 – 29
Remanufacturing	30 – 31

Partner to the mining and processing industry

Everything from a single source

Rolling bearings make an essential contribution to technological progress in the mining and raw materials processing industry. To that end, the prevailing harsh operating and environmental conditions require extremely robust bearings. Over a century of experience in the rolling bearing business, combined with an unsurpassed customer focus, make Schaeffler an excellent choice as your strategic partner.

Customers from 60 industrial sectors rely on the industry-leading quality of Schaeffler's acclaimed FAG and INA product brands. Our portfolio of over 225,000 industrial products – complemented by our comprehensive lineup of condition monitoring systems, mounting services and maintenance tools – is one of the largest in the rolling bearing industry. All of which ensures that we can offer a solution for virtually any application in the mining and raw materials processing industry.











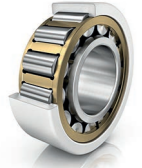



Intensive research and development as well as constant collaboration with manufacturers and operators result in high levels of operational reliability for our bearings. Moreover, our solutions are also extremely cost effective – which further boosts efficiency!

Close collaboration with customers as well as partnerships with universities and research institutes in the mining and raw materials processing industries have allowed us to gain detailed knowledge of customer-specific requirements. Because we are always at the cutting edge of technology, we can supply the entire industry with the right bearings and corresponding services. Accordingly, our focus is on ensuring high levels of reliability under the harshest environmental conditions.

Overview of benefits for our customers

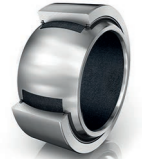
- Proven quality of the FAG and INA product brands
- High operational safety
- Long rating life
- High load-carrying capacity and stability
- Reduced maintenance requirements
- Easy to install and remove
- Suitable for heavy vibration stress
- Resistance to very high temperatures

Products and services for your success

<p>INA and FAG cylindrical roller bearings</p> 	<p>FAG split cylindrical roller bearings</p> 	<p>INA axial cylindrical roller bearings</p> 	<p>Spherical roller bearings</p> 	<p>Condition monitoring solutions</p> 
<p>FAG axial spherical roller bearings</p> 	<p>FAG tapered roller bearings</p> 	<p>INA slewing rings</p> 	<p>FAG split spherical roller bearings</p> 	<p>Lubrication solutions</p> 
<p>INA spherical plain bearings</p> 	<p>FAG plummer block housings</p> 	<p>Four-point contact ball bearings</p> 	<p>Deep groove ball bearings</p> 	<p>Mounting</p> 

Our portfolio of products and solutions for your machines and equipment (excerpt)

Process	Equipment/machine	Product/Solution																
		Cylindrical roller bearings	Split cylindrical roller bearings	Spherical roller bearings	Split spherical roller bearings	Spherical roller thrust bearings	Tapered roller bearings	Axial cylindrical roller bearings	Four-point contact ball bearings	Slewing rings	Deep groove ball bearings	Spherical plain bearings	FAG plummer block housings	Assembly	Lubrication solutions	Condition monitoring	Rolling bearing reconditioning	
Mining	Shearer loader	•		•				•		•					•	•	•	○
	Tunnel boring machines							•		•					•	•	○	•
	Drilling machines	•		•		•		•							•	•	○	○
	Bucket wheel excavator	•	•	•	•						•	•		•	•	•	•	•
Loading	Dragline excavator	•		•				•					•		•	•	•	•
	Cable excavator, hydraulic excavator	•		•				•					•		•	•	•	•
	Pick-up equipment, spreader	•	•	•	•						•	•		•	•	•	•	•
Transportation	Dump trucks	•		•				•				•			•	•	○	○
	Conveying systems			•	•			•				•		•	•	•	•	•
	Shaft hoisting equipment	•		•	•								•		•	•	•	•
Crushing	Crushers	•		•				•	•			•	•	•	•	•	•	•
	Vertical mills	•		•				•				•	•	•	•	•	•	•
	Roller presses	•		•		•				○			•		•	•	•	•
	Tube mills			•	○									•	•	•	•	•
Classification	Vibratory screens	•		•											•	•	•	
	Rotary kilns			•				•						•	•	•	•	○
Refinement	Pelleting plants, sintering plants	•		•				•			•		•		•	•	•	•

• available ○ optional

Indispensable: Bucket wheel excavators in surface mining



The solution: Split cylindrical roller bearings

Many bucket wheel excavators have the gearbox for the bucket wheel drive mounted directly to the bucket wheel shaft. Due to the forged flanges, assembly is only possible when split cylindrical roller bearings are used. This design facilitates fast bearing replacement, thereby considerably minimizing downtime and lowering maintenance costs.

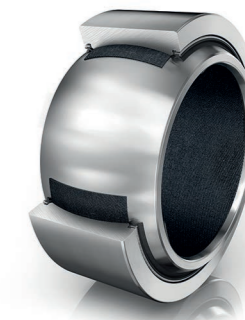

Maintenance-free spherical plain bearing with ELGOGLIDE sliding layer

Ensures high reliability:

Maintenance-free INA spherical plain bearing

For more than 60 years, we have offered plain bearing solutions for the mining industry. A recent example: INA spherical plain bearings featuring the high-performance ELGOGLIDE sliding layer for dynamic surface pressures of up to 300 MPa. These maintenance-free dry plain bearings offer extremely high load-carrying capacity within a very small design envelope. Thanks to ELGOGLIDE, they are highly durable and perfect for small swiveling motions.

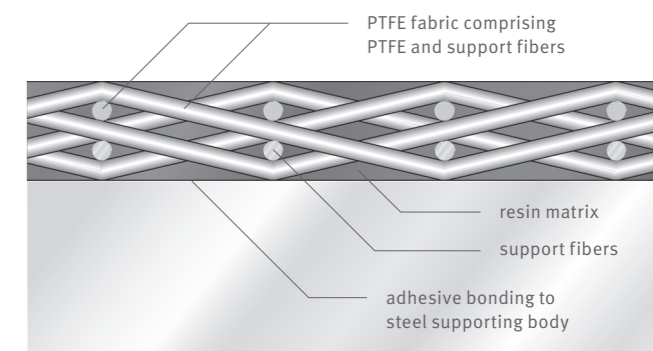

Structure of the ELGOGLIDE fabric

INA spherical plain bearings are available for radial, axial and combined loads.



Large-size spherical roller bearing with angular adjustability

Surface mining for raw materials: Low operating speeds, combined with high loads and frequent machine start-ups mean stress on every component. Bearings used here must therefore have a rating life of 75,000 hours or ten years.

The challenge

During operation, the excavator body pivots but the boom does not continually move up and down. Consequently, the excavator boom's bearing arrangement must support mostly static loads as well as vibrations caused by the digging motion of the bucket wheel. Spherical roller bearings and spherical plain bearings are ideally suited to these requirements.

The bearings in the bucket wheel shaft must be able to support high loads and shock loads as well as compensate for shaft deflections and misalignment. Large-size FAG spherical roller bearings offer angular adjustability and a high load-bearing capacity. This is why they offer the best possible performance characteristics for this application.

SPECIAL SERVICE

Our experienced mounting technicians can help you install and remove rolling bearings as well as provide advice on selecting the right mounting tools. Proper mounting is an essential prerequisite for achieving the bearing's maximum rating life.

A real-life example

To save time and costs, a surface mining company wanted to replace the bearings on an excavator's bucket wheel shaft in the field without having to remove the gearbox. Schaeffler worked with the customer to develop bearing and mounting tools that were specially designed for this application. All necessary mounting and dismounting steps were planned and implemented in close collaboration with the customer. This allowed the bearing to be replaced during a short, planned maintenance event – which significantly reduced downtime and costs.



Underground giant: The tunnel boring machine

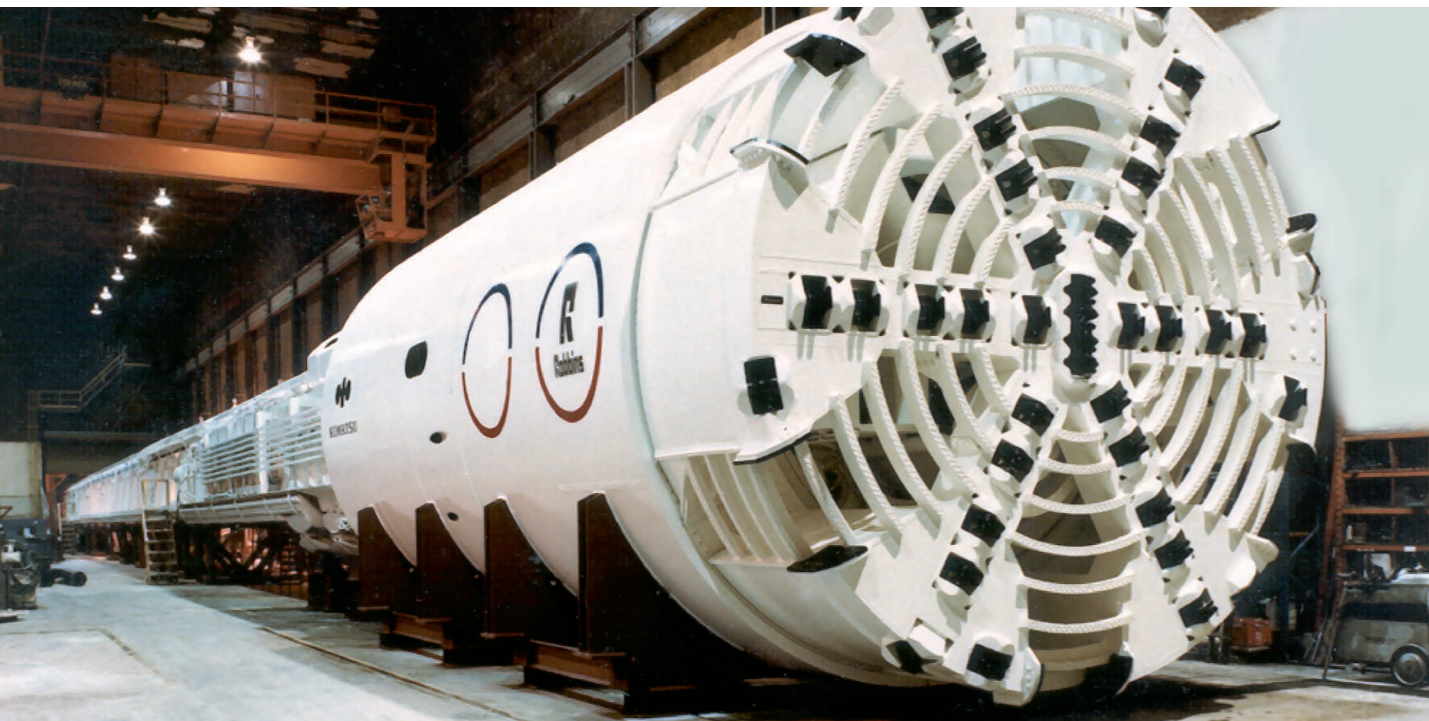

FAG tapered roller bearing

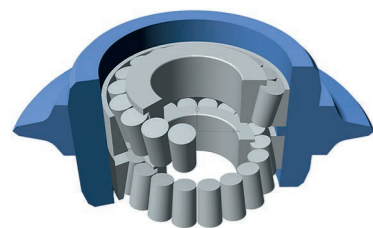

Calculation of a cutter bearing using Schaeffler's proprietary Bearinx calculation program

The tunnel boring machine is used to facilitate the installation of new traffic routes and supply lines as well as digging tunnels. The dimensions of these machines can be immense. With a drill head diameter of up to 20 meters, low-friction and reliable rolling bearing systems are required.

The challenge

Hard rock, loose stones or damp soil make developing bearing solutions for the various tunneling machines a challenge, to say the least. The changing operating conditions during tunneling are accompanied by different loads, which must be factored into the bearing design. Ensuring that the bearings and seals are highly resistant to dirt, vibrations and pressure differences is an absolute prerequisite.

The solution: FAG rolling bearing systems

For decades, Schaeffler has been a recognized and innovative premium supplier for manufacturers of tunnel boring machines. One of our products is the main bearing – the heart of the tunnel boring machine. Large axial-radial cylindrical roller bearings or tapered roller bearings in

O arrangement from FAG are ideally suited for this purpose. With an outer diameter of several meters and a weight of up to 30 tons, they take on gigantic dimensions. Operative tasks of the main bearing include accommodating the rotating drill head of the machine, taking up the enormous feed forces and supporting the massive tilting moments.

The roller bits also pose a real challenge to bearing systems, which are characterized by high impact loads, pronounced speed differentials and acceleration as well as high operating temperatures. A reliable seal is indispensable for ensuring a long bearing life. Case-hardened FAG tapered roller bearings in O arrangement deliver everything that this demanding application requires.

A massive load test for bearings: Shaft boring machines

Vertical shaft boring machines are primarily used for production and ventilation shafts as well as mining ore channels, but they can also be utilized to create rescue shafts.

When the oversized drilling rigs commence work, it is vitally important that each machine component meet the stringent requirements of the mining industry.

Axial spherical roller bearings with solid brass cages, for example, are used as the main bearings in drilling machines to support the weight of the drill rig and take up the drilling forces. The different load scenarios experienced during pilot hole drilling (pre-drilling) and subsequent enlargement drilling are handled by high-quality rolling bearings from Schaeffler. They ensure that the entire process runs smoothly.

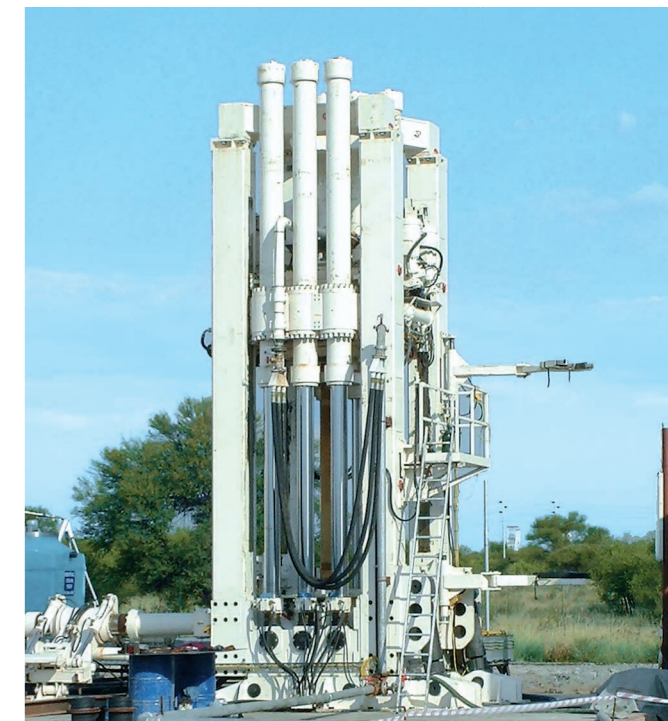

X-life axial spherical roller bearing with solid brass cage

SPECIAL SERVICE

Bearing reconditioning often offers significant savings. This service is one of Schaeffler's core competencies and is offered at several certified locations around the world. We offer reconditioning services for all types and designs of rolling bearings – regardless of manufacturer.

Schaeffler can recondition or modify rolling bearings with an outside diameter of up to 4,250 mm. Even larger bearings can be reconditioned on request – including the main bearings of tunnel boring machines, for example.

In general, the costs for such reconditioning are significantly lower than those of a new bearing – in most cases, with shorter delivery times.



Energy-intensive: Dragline and cable excavators



Case hardening ensures increased wear resistance and fatigue strength

The specialized solution: Hardened rope sheave bearing

Bearings used in rope sheave applications must be designed for correspondingly heavy loads. To reliably accommodate combinations of radial, axial and tilting forces, we offer FAG tapered roller bearings made from case-hardened steel.

Case hardening in conjunction with carbonitriding makes the rolling bearings even less sensitive to the vibrations and shock levels that occur during operation. The bearings also become more wear resistant, offer good overrolling resistance, and are less prone to cracking.

Because they require extremely large amounts of electric power, dragline and cable excavators connect directly to the high-voltage grid.



Matched tapered roller bearing in an O arrangement

The challenge

Every restart always involves high costs. This is why it is important that unplanned downtime be avoided at all costs. Ensuring the operational of the rolling bearings used in these applications is an absolute necessity. Accordingly, the bearings must have a high load-carrying capacity, be shock resistant, and require as little maintenance as possible.

Schaeffler offers a technically as well as economically optimized solution for every bearing location in draglines and cable excavators – regardless of whether it's a rope drum, rope sheave, rope pulley, slewing gear or gearbox. All products used have been approved by plant operators and have proven themselves in practice by customers over a period of many years.

Frequently used bearings in these applications include spherical roller bearings, large matched tapered roller bearings and cylindrical roller bearings.



Large spherical roller bearing with brass cage

SPECIAL SERVICE

Trouble-free and optimized operation of complex machines and equipment can usually only be achieved through condition-based maintenance. Here, Schaeffler uses vibration-based diagnosis as a preferred method, which makes it possible to detect damage inside machines at a very early stage.

This allows damaged components to be replaced as part of a planned maintenance activity – thereby avoiding unscheduled downtime. In addition to vibration monitoring, Schaeffler offers a system that evaluates the condition of the lubricant used.



Available services include:

- Routine measurements and inspections
- Installation and setup of measurement technology and condition monitoring systems
- Troubleshooting and repair of complex industrial equipment
- Comprehensive service packages
- Global support through state-of-the-art technologies, including remote diagnostics and augmented reality

Non-stop operation in surface mines throughout the world: Dump trucks



The result is a compact design with high load-carrying capacity and rigidity that offers a very long operating life. Less sensitive to vibrations and shock loads, the bearings are more wear resistant, have good overrolling resistance, and reduce crack formation due to surface damage. All of which contribute to longer bearing life.

For electric motors, we use current-insulated deep groove ball bearings and cylindrical roller bearings to prevent damage from electric current. To that end, Schaeffler's proprietary Insutect ceramic coating is applied to the inner or outer ring. These bearings have long relubrication intervals and are suitable for large temperature fluctuations. FAG cylindrical roller bearings with robust brass cages are the ideal solution here.

The planetary gears in the dump trucks primarily contain spherical roller bearings and cylindrical roller bearings. These bearings have a very high load-carrying capacity – in an extremely compact design. They also have close tolerances which, together with the specially chosen internal clearance, facilitate uniform load distribution. Thanks to application-specific cages, the high centrifugal forces can be reliably accommodated.

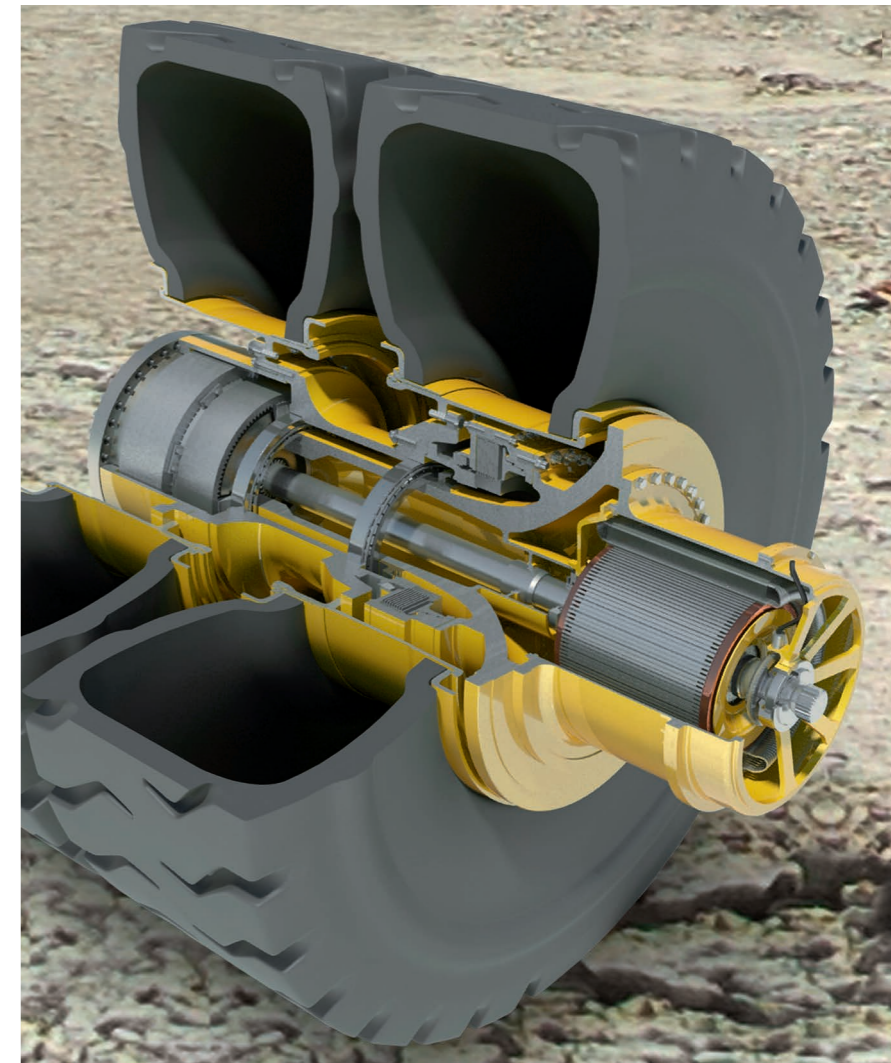

Many impressive Schaeffler solutions are hidden in the huge wheels of dump trucks.

They include not only extremely durable wheel bearings for front and rear wheels, but also complete bearing solutions for the engines and planetary gears that are integrated into the rear wheels. The main bearing supports for the rear wheel, for instance, are designed with two tapered roller bearings – each measuring up to one meter – in an O arrangement.



Bearing solutions inside the wheel hub drive
 Wheel bearing: case-hardened tapered roller bearings
 Electric motor: current-insulated deep groove ball bearings
 Planetary gear drive: heavy-duty spherical roller bearings
 Electric motor: current-insulated cylindrical roller bearings

SPECIAL SERVICE

Bearinx Simulation Suite

Bearinx can be used to perform detailed analyses on rolling bearings – including individual rolling element contact points – in order to calculate their suitability for each application. Rolling bearing loads in complex machine systems can be calculated, displayed and documented while taking a broad range of ambient conditions into account. In addition to normal operating conditions such as load, speed, lubrication and cleanliness, the impact of elastic environments on bearing life can be depicted, and the dynamic response of rolling bearings and components analyzed accordingly. The same applies for natural frequencies, natural vibration forms, critical speeds and out-of-balance responses for shaft systems.

The Bearinx Simulation Suite from Schaeffler offers not only conventional rolling bearing calculation and analysis, but also the option of dynamically simulating rolling bearings and systems as well as performing detailed contact calculations (Simpla, Caba3D, Telos).

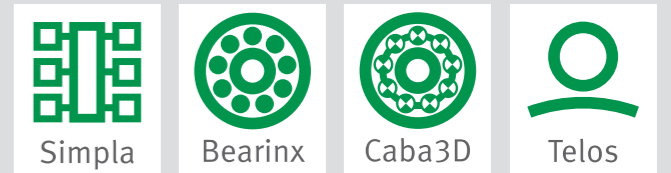

Indispensable in mining: Conveying systems



Sealed spherical roller bearing

Conveying systems such as belt conveyors move immense amounts of material across large distances every day, which makes them indispensable in mining. Primary applications for rolling bearings in conveyor systems include gearboxes, pulleys and idlers. Various types of bearings – which depend on the output required, the available design envelope and the transmission ratio – can be found inside conveyor system gearboxes.

For the drive drums, we recommend split or unsplit FAG spherical roller bearings. Both designs can withstand equally high loads and compensate misalignment and shaft deflections. The use of split spherical roller bearings is particularly interesting from an economical perspective. When bearings need to be replaced, for example, significantly fewer work steps and less time are required.

For the non-driven return pulleys (most of which have internal bearings), special cylindrical roller bearings or spherical roller bearings are used. These bearings have an exceptionally long rating life and are also very easy to maintain, thanks to their long relubrication intervals.

Ball bearings are the primary choice for idlers as they exhibit very low friction levels – even at high speeds. Here, too, we offer very durable bearings that are maintenance free, thanks to lifetime lubrication.

Our product portfolio also features a complete selection of housings (unsplit or split) for conveyor systems. For our customers in North and South America, we offer SAF/SDAF housings in inch dimensions.

Innovation: SNS housing

Thanks to an all-new design that increases service life by up to 50 percent, Schaeffler is setting a new standard with our innovative SNS large-size bearing housing. This ingenious housing also provides outstanding protection against the ingress of contamination under extreme environmental conditions. SNS housings can significantly reduce the total cost of ownership (TCO) at your facilities.

At a glance: Benefits of the new SES and SNS housing generations:

- Minimal maintenance outlay
- Easy to install using, for example, machined locating faces
- Prepared surfaces for monitoring and maintenance equipment
- Superior sealing performance



SES housing with split spherical roller bearing



SNS housing



Split FAG spherical roller bearing



Spherical roller bearing with brass cage

SPECIAL SERVICE

Reduced downtime is the no. 1 cost-savings benefit gained by installing split spherical roller bearings. To wit: The first time a global mining company installed a split FAG spherical roller bearing in its conveyor system, downtimes for replacing conventional standard bearings were reduced from 22 hours to just 3 hours. Accordingly, the company's overall costs for replacing the bearing were reduced by approximately 151,000 euros.

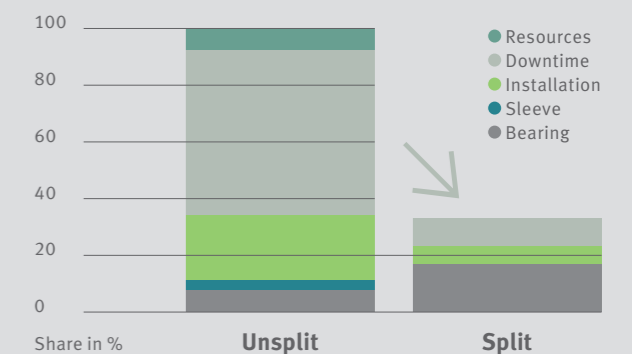

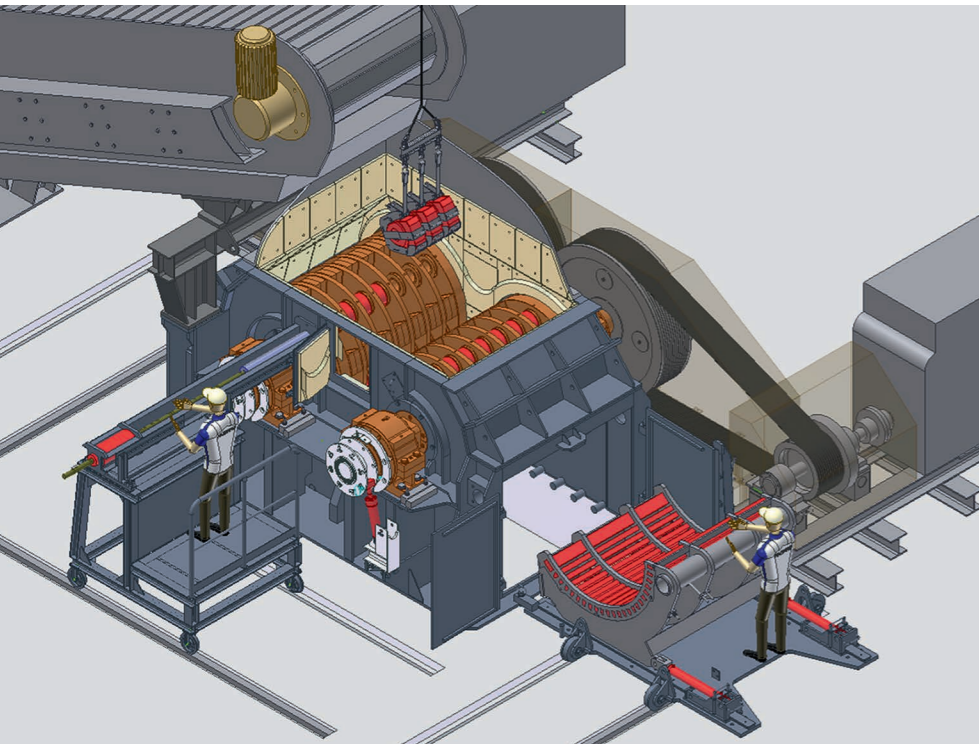

Hammer crusher

The challenge

Heavy-duty bearings are a necessity in crushing machines. Angular adjustability is also needed to compensate for misalignments in the bearing seats and tilting caused by shaft deflection.

The solution: E1 X-life spherical roller bearings

For the main bearing supports of jaw crushers, we recommend using FAG E1 spherical roller bearings in X-life quality. These bearings were specially developed for the heaviest loads and are employed wherever angular adjustment is required. They operate reliably – even under the harshest environmental conditions.



What are the advantages of X-life quality vs. standard bearings?

- Up to 70 percent longer operating life under the same load conditions – or the same operating life under significantly higher loads
- High static safety
- Minimal lubricant stress thanks to less friction and low bearing temperatures.

For our customers, this means high equipment efficiency and reduced operating costs. Moreover, the ability to downsize allows for more cost-effective bearing arrangements.



Spherical roller bearings in X-life quality

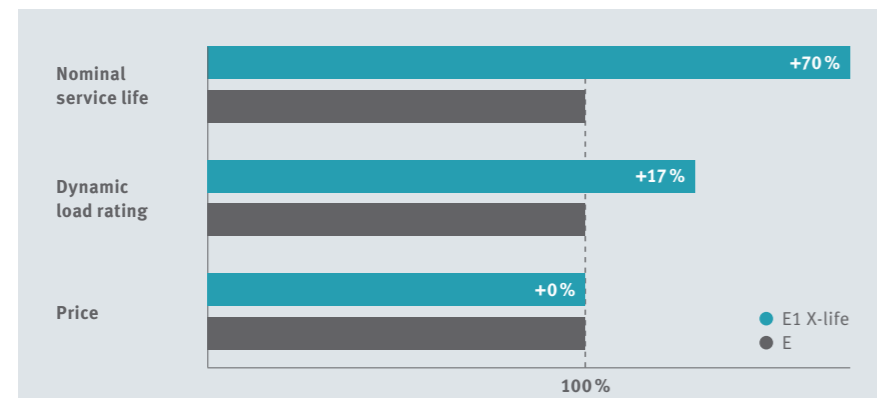

Above all, E1 X-life means: 1 increased nominal rating life

High dynamic loads: Vertical mills

For decades, Schaeffler has been working closely with all major manufacturers of vertical mills. This means we have extensive experience in designing bearing arrangements for grinding rolls, rocker arms and separators.

The challenge

Inside vertical mills, bearings are primarily subjected to high, dynamic loads. Typical requirements include:

- Radial and axial load-carrying capacity
- Compensation of the shaft's length under load
- Very high load-carrying capacity in a compact design
- Manufacturer-specified long rating life

Large FAG tapered roller bearings have equally high radial and axial load capacity as well as a broad usable speed range. They reliably take up forces and ensure precise and rigid shaft guidance. These bearings can be adjusted and disassembled, which makes them easy to mount.

Our product range also includes many customized solutions that our application engineers have developed and implemented in conjunction with our customers.

One solution: Tapered roller bearing units

Thanks to our comprehensive product portfolio, Schaeffler can offer an efficient solution for every bearing need. One of the most common designs for grinding rolls is a cylindrical roller bearing used as a non-locating bearing in conjunction with a spherical roller bearing or a tapered roller bearing unit. This allows the contact, tilting and axial forces acting on the grinding roll to be optimally accommodated, and the bearing arrangement can support high dynamic loads. As such, tapered roller bearing units in X or O arrangements are becoming increasingly popular.



2-row tapered roller bearing unit in an X arrangement



Vertical mill



A vertical mill's grinding rolls (cement processing)

High efficiency – minimal energy: Roller presses

Compared to tube mills, for example, roller presses have much greater efficiency and material throughput. Because they consume roughly 40 percent less energy, they are becoming ever more popular in pre-, hybrid- and finish grinding.

The challenge

The preferred solution for supporting rolls in roller presses, spherical roller bearings offer the following benefits:

- High load-carrying capacity
- Robustness
- Angular adjustability
- Ease of handling
- Ease of installation

A development partnership between Schaeffler and leading machine manufacturers, however, has produced an alternative bearing solution that's exceptionally economical and reliable.

The requirements were:

- High radial load-carrying capacity
- Optimal cross-sectional utilization with limited height
- Even stress distribution
- Easy to mount, dismount and troubleshoot



1. Schaeffler has created an unusual spherical roller bearing for what is currently the world's largest roller press. Its outer diameter is just shy of two meters, and one roller alone weighs 50 kilograms
2. Four-row large cylinder roller bearing in X-life quality with pin-type cage



The especially cost-effective solution: Four-row cylindrical roller bearings

Four-row FAG cylindrical roller bearings with pin cages allow the largest possible number of rolling elements per row, which results in a very high radial load-carrying capacity. This means that four-row cylindrical roller bearings enable much more compact designs. The fact that cylindrical roller bearings are easily disassembled also enables easy mounting, dismounting and raceway inspection on the bearing rings.

High operational reliability required: Tube mills

On-site Schaeffler experts: "ASB Grinding Mills Competence Center"

Customers from around the world place their trust in the Schaeffler experts in Melbourne, Australia, and their many years of experience. Services offered range from consulting and design to the right advice for demanding bearing solutions.

- Development and provision of field-proven bearing and housing units
- Calculation and technical consultation
- Support with repair work and service projects
- Lubricant recommendations for challenging applications

Creative solution: Sliding sleeve housings

Tube mills are exposed to extreme temperature fluctuations. Consequently, these special prevailing environmental conditions require an innovative bearing design. The ASB-Schaeffler experts offer a complete solution consisting of spherical roller bearings and sliding sleeve housings that can compensate for linear expansions in horizontal

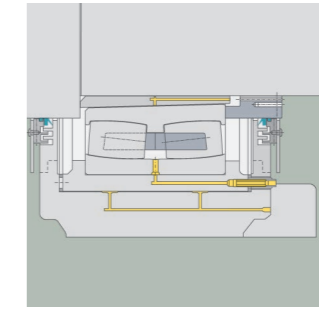

Sliding sleeve housings



mills. The non-locating bearing no longer displaces between the housing and sliding plate; instead, this occurs between the sliding sleeve and housing bore. The continuous supply of lubricant between the sliding sleeve and housing bore ensures a low coefficient of friction, should the tube mill become elongated. The benefit to our customer can be measured in economic terms: no more annual bearing replacements – less downtime – higher production volumes.

Rollers with end profiling set a new standard

Schaeffler is systematically transitioning all spherical X-life roller bearings in the applicable sizes to new rolling elements. The new barrel rollers feature end profiling (an optimized microgeometry on the ends of the rollers), an enhancement that significantly increases their robustness in this application.

While spherical roller bearings with non-profiled rollers can exhibit friction-induced material wear after a short operating time, the edge pressure caused by abrasive material wear occurs much later on bearings with profiled rollers. The operational reliability and operating life are significantly increased, particularly in mining and processing applications. With its large-size bearings featuring rollers with end profiling, Schaeffler is setting the new standard for catalog bearings.

More information can be found in our Technical Product Information (TPI) 251.

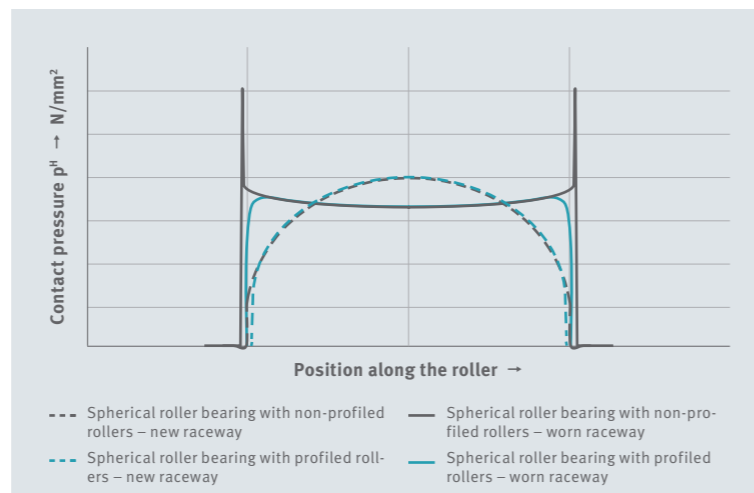

Comparison between the contact pressures for profiled and non-profiled rollers at various times during operation >

SPECIAL SERVICE

Lubricators

Lubricators have a limited service life, as they are continually exposed to mechanical loads, aging and contamination while in use. This is why fresh lubricant must be supplied at defined intervals to ensure sufficient lubrication, which, in turn, helps prevent subsequent damage and reduces the risk of application failure.

Schaeffler's CONCEPT-series automatic lubricators can supply almost all industrial machines and systems with oil or grease – with pinpoint accuracy. The product range encompasses basic and cost-effective single-point lubrication systems (CONCEPT1) as well as more complex lubrication systems that can accommodate multiple lubrication points (CONCEPT2, CONCEPT4 and CONCEPT8). Thanks to flexible programming options and the ability to configure comprehensive lubrication solutions, there are virtually no limits for our customers.

Our lineup is supplemented by a broad range of accessories for the automatic lubricators as well as manual lubrication tools and custom-filled and unfilled lubricant cartridges.



Only the very best bearings make it here: Vibratory screens



Almost no industrial bearing is subjected to as much stress as a vibratory screen bearing. In particular, the bearing cages are subjected to high stresses due to radial acceleration. In unfavorable circumstances, axial accelerations can also be overlaid.



Spherical roller bearing with a Durotect CK-coated bore

The rotating imbalance produces circumferential shaft deflection and additional sliding movements in the bearings. This, in turn, increases friction levels and, therefore, the bearings' operating temperature. Nonetheless, the bearing is expected to deliver a long service life.

The solution: FAG spherical roller bearings with a thin-layer chromium-plated bore

Only high-quality, high-performance rolling bearings can withstand the extreme loads that occur in exciter units inside vibrating machines. This is why we recommend spherical roller bearings in premium X-life quality: They reliably offer a rating life is up to 70 percent longer than conventional bearings in the same application.

To protect against fretting corrosion, we supply the bearings with a Durotect CK-coated bore. This ensures that the necessary thermally induced displacement between the bearing bore and shaft is maintained over a long service life.

FAG spherical roller bearings with a Durotect CK-coated bore comply with DIN/ISO standards for dimensions and tolerances; they can be interchanged 1:1.

What are the customer benefits?

- Greater operational safety
- Coated bore ensures longer operating life
- Heavy shock loads and radial acceleration are accommodated
- No fretting corrosion
- Coated inner ring bore allows for unencumbered thermal expansion of the shaft
- Exceptional load-carrying capacity

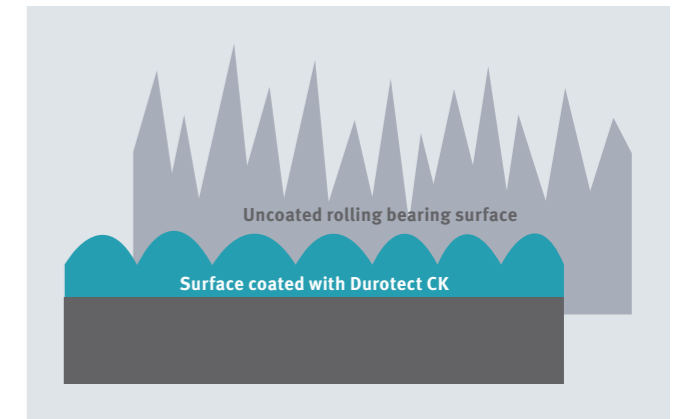

A question of structure: Surfaces coated with Durotect CK are more wear-resistant and have a friction-reducing effect

What exactly is Durotect CK?

The Durotect CK coating belongs to the family of hard chromium processes. A special surface structure lends this hard chromium variant special properties that reduce friction and wear.

- Layer thickness 1.5 – 3 µm
- Hardness 950 – 1300 HV
- Corrosion protection to DIN 50021 SS 120 hours
- Chemically resistant

SPECIAL SERVICE

Schaeffler's portfolio of training programs offer a broad range of product and analysis courses that specifically strengthen your internal skill set with first-hand, practical experience. Our training courses start with basic knowledge and an overview of applicable products. Advanced training courses expand the theoretical expertise gained and are complemented by practical exercises. The courses also prepare you to have your condition monitoring know-how tested and certified at various levels in our DIN ISO 18436-2 certification courses.



Unplanned downtime is not an option: Rotary kilns



Rotary kilns are sizable investments that can cost several million euros. At full capacity, a rotary kiln is in operation around the clock. Unplanned downtime can cause exceptionally high costs and damage, especially if a cement plant uses a production line and a rotary kiln.



The challenge

Bearing arrangements inside rotary kilns consist of a minimum of two stations, each with two radial track rollers. These are subjected to elevated temperatures, shock loads, high radial and axial forces as well as high dust levels. Each station also includes two axial rollers.

The solution: Reliable, single-unit radial and axial track rollers

For these bearing positions, Schaeffler offers special designs that are often customized to the customer's specifications.

The radial track roller is comprised of a track roller with shaft, high-load spherical roller bearings, and a shared frame housing. In the case of axial track rollers, tapered roller bearings in the hub are positioned on a fixed vertical shaft shrunk into the base plate. Proven Arcanol greases – which can accept higher loads than standard greases – are used to lubricate the rolling bearings.



Cost-effective solutions from a single source: axial and radial track roller supplied as complete units

Custom-tailored: Bearing solutions for sintering and pelleting plants



Track roller

Pelleting plants offer a wide range of applications for Schaeffler's portfolio of high-quality bearings.

For example, we support the pelletizer plates with special slewing rings and recommend radial and axial track rollers for the pelletizing drums similar to those used in rotary kilns (see page 22). We have developed special support and track rollers for the bearing arrangement of the pelletizing or sintering carriages in the ensuing hardening process. In smaller plants, the support rollers are mounted on the carriage axle using a deep groove ball bearing as a locating bearing and a cylindrical roller bearing as a non-locating bearing. For larger pelletizing carriages, we use bearing packs in O arrangement that are comprised of two tapered roller bearings. We even have a cost-effective cylindrical roller-based solution for the pressure rollers used to divert the carriages.

In the lifting and lowering wheels that are used to drive and guide the carriages, we employ large standard spherical roller bearings with special housings. Choosing a lubricant can be a challenge, due the high forces or extreme temperatures. For these situations, we offer the right lubrication solution from our proven selection of Arcanol greases. We can help you with the right mounting tools or our mounting service – especially for the large spherical roller bearings used for the lifting and lowering wheel as well as for press-fitting the wheel.

SPECIAL SERVICE

Because the wrong lubricant can compromise the rating life of rolling bearings and cause damage, Arcanol greases are subjected to rigorous testing. Only greases that meet the strict guidelines and tests in the Schaeffler lubricant laboratory are made available to our customers. Our stringent quality-control procedures applied are among the most demanding in the market. No surprise, then, that Arcanol greases meet the highest quality requirements.

We offer a variety of Arcanol greases, depending on the application: For vibratory screen machines, for example, Arcanol VIB3 as well as MULTITOP, LOAD400 and LOAD200 are used. For higher operating temperatures, temperature-stable special-purpose greases such as Arcanol TEMP120 are the right choice.



Ever-present: Small electric motors and pumps

Electric motor & pump

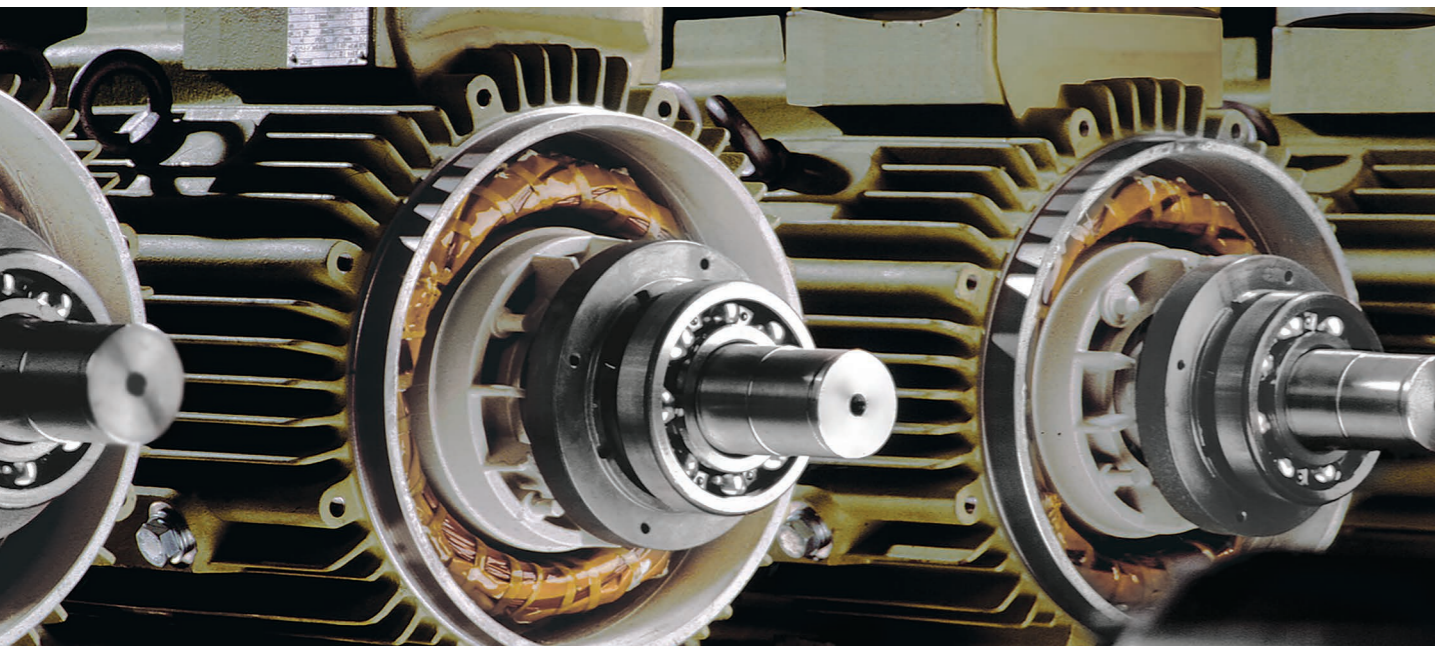

How to save on energy costs: Generation C deep groove ball bearings in electric motors

Small electric motors for powering industrial pumps and fans are widely used in mining. In general, small- to medium-sized deep groove ball bearings or angular contact ball bearings, which are characterized by their durability and reliability, are employed here. For these applications, we recommend exceptionally quiet and low-friction FAG Generation C deep groove ball bearings. Thanks to their optimized internal design and high production quality, the bearings' internal friction was able to be reduced by 30 percent. This means the motor consumes less energy. Rating life also increases because the temperature spikes inside the ball bearing are less pronounced.

X-life bearings in pumps – how to increase the bearing arrangement's overall efficiency

Bearings inside pumps must reliably accommodate radial and axial loads while also resisting vibrations and shocks. Durability, a long grease life and low maintenance are also required. This is where FAG double-row angular contact ball bearings in X-life quality are the perfect solution. Thanks to their large 30 ° contact angle, they can be subjected to correspondingly high axial loads in both directions.

A featured performer in both bearings: Our innovative HRS lip seal

Particularly at high speeds, deep groove ball bearings as well as angular contact ball bearings benefit from our newly developed HRS seal. This is because, under these conditions, the frictional torque and heat produced are significantly lower vs. conventional seals. And the sealing performance? Well, that's been improved, too. Try it out!

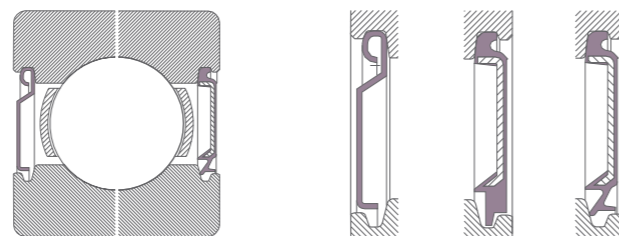

Sealing action	Z	BRS	HRS
Retain grease in bearing	+	++	++
Dust, dry contamination	+	++	++
Damp atmosphere	+	+	++
Liquid splashes	-	-	++
Rotating bearing outer ring	+	++	++
Slight differences in pressure	-	-	++

(++) particularly suitable (+) suitable (-) unsuitable

Fast support when you need it: Our certified distribution partners

Sales & service

Just imagine: A vital gearbox bearing fails on a large bucket wheel excavator. Or: On the drive drum of a conveyor belt, the seal and bearing raceway of the spherical roller bearing have been worn away after extended operation. Both scenarios can result in the machine being taken out of service and lead to high costs. Quick thinking is required here.

With the sales partner concept, we ensure that our products and services are available around the world at the same high level of quality via our distribution partners. In the event of damage, we can offer you expedited assistance. Whether it's from a local Schaeffler sales office or at one of our many nearby distribution partners, we'll make sure you receive a suitable replacement product – including professional installation service (which is particularly critical for large bearings in mining and processing applications).

Our distributors are certified according to very specific criteria. This safeguards the quality of the technical advice that's provided when selling our premium INA and FAG product brands. Training courses ensure that distributors are fully knowledgeable about the different bearing solutions available and can offer expert assistance. In many cases, our distributors receive specific bearing training for mining and raw materials processing.

Customers can be confident that they always receive good advice when they contact our authorized and certified distributors. Our "Authorized Distributor"-certified dealers have direct access to high-performance rolling bearings from Schaeffler as OEM parts.

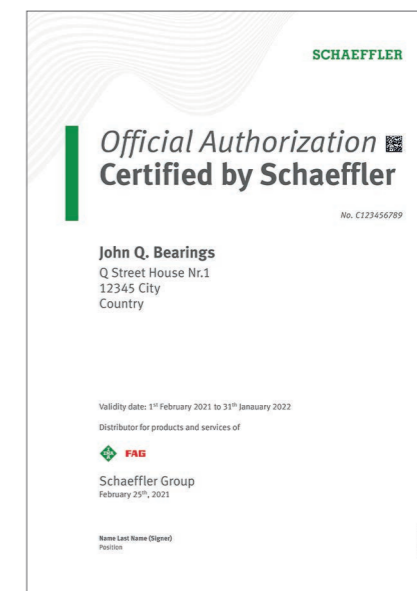

SPECIAL SERVICE

In the past, bearings were regreased at specific time intervals. Grease quantities and lubrication intervals were calculated numerically. With the Schaeffler GreaseCheck compact grease sensor, condition-based regreasing can be performed. The grease sensor is used to visually measure the following parameters directly in the bearing: Water and Fe content, aging effects and grease softening. Measurement signals are transmitted via cable to the analyzer. Measurement data can be read via a variety of interfaces (analog, digital, CAN bus).

Benefits:

- Up-to-date information on the condition of the grease inside the bearing
- No expenses for manual sampling and grease analysis
- Automated, requirement-based relubrication possible
- Cost savings for new and used grease (sustainability)



OPTIME

The Schaeffler OPTIME condition monitoring system offers comprehensive condition monitoring at an exceptionally low cost.

Schaeffler OPTIME is an easily scalable condition monitoring solution that has been developed for various industrial sectors and can be leveraged in a variety of machines in speed ranges from 120 rpm to 5,000 rpm.

When the solution was developed, special attention was paid to ensuring very straightforward commissioning, convenient modularity and versatile utility. User outlay was minimized as far as possible for each process step. These features make Schaeffler OPTIME particularly suitable for condition-based monitoring of a large number of machines.

The underlying hardware basis of the solution is the special array of OPTIME wireless sensors which, together with the OPTIME gateway, form a mesh network. Measurement data can be sent to the Schaeffler IIoT hub without a connection to the customer's IT system. The data is then analyzed using proprietary algorithms specially developed for OPTIME. The results are subsequently presented to the user in the OPTIME app, prioritized and aligned with the relevant task area. The OPTIME solution is supplemented by a dashboard where customers can manage their installation and view all relevant status information.



 **reddot winner 2021**

Benefits of Schaeffler OPTIME:

- **Cost-effective monitoring:** Hundreds of rotating machines can be monitored for just a few cents a day – up to 50% more cost-effective than hand-held devices.
- **Fast installation:** Mounting the sensors and configuring the app takes just a few minutes – no prior knowledge is needed.
- **Drawing on expert knowledge:** Digital service provides professional diagnosis based on expert algorithms and machine learning, available 24/7 via the app – ensuring you always make the right decision.
- **Perfect for beginners and advanced users:** Intuitive operation, provides key information and offers extensive add-ons to suit different users and requirements.

ProLink CMS Condition Monitoring System

The ProLink CMS condition monitoring system is a modular system comprising a CPU and one or more vibration measurement modules.



Thanks to its modular design, ProLink CMS can be adapted to individual customer requirements. External vibration sensors connect to the system, which are then fitted at the respective measuring points. This makes it possible to use the system under harsh environmental conditions such as high temperatures. Typical applications include surface temperatures in excess of 70 °C. Ready-to-use templates for monitoring rolling bearings, motors, gearboxes, fans and pumps simplify additional configuration. ProLink CMS only needs information about the machine's geometry, such as the installed bearing type or the number of fan blades. An integrated learning mode enables individual adjustment of alarm thresholds to optimize monitoring.

Modules and functions – ProLink condition monitoring system

- Additional modules**
ProLink can be individually expanded to include additional measurement modules for a range of different applications (in planning)
- Vibration module with speed detection**
Extremely high signal quality (24 bit), high-quality signal processing
- Fieldbus connection**
Under development: Profinet and CC-Link IE Field
- Cloud communication**
Ethernet, OPC/UA, MQTT, Web services
- SmartWeb**
 - Configuration assistant
 - Automatic learning mode

Benefits of ProLink CMS:

- **Easy setup,** thanks to automatic monitoring configuration for balance of plant assets such as motors, fans and pumps.
- **Configuration, trend display and initial analysis** are performed directly on the device with the help of the integrated web server and a standard web browser.
- **A range of different options for integration** into your infrastructure with the help of digital interfaces (e.g., OPC/UA) and the use of a modular fieldbus module. This enables a high level of transparency by providing all machine condition metrics (e.g., for the customer's plant visualization system, maintenance planning system or quality assurance).
- **Optionally available:** Via the integrated cloud interface, customers can utilize Schaeffler's automatic "Condition Analyzer" machine diagnostic.

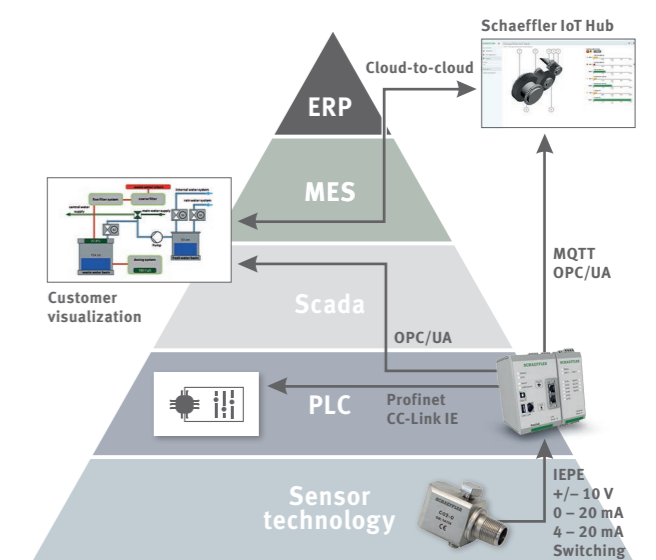



Schaeffler's mounting service offers professional mounting and dismantling services for rolling bearings. Our mounting personnel are trained specialists who provide reliable, rapid, and competent assistance. They have acquired in-depth knowledge and many years of experience in all sectors of industry and application scenarios. The services are provided quickly and reliably worldwide: Either at the customer's location or in Schaeffler's workshop facilities.

Mount it yourself or have it mounted?

Correct mounting has a significant effect on the rating life of a bearing. Take advantage of the benefits:

- Increased rating life
- Higher system availability
- Reduced downtimes
- Mounting experts available worldwide
- Process optimization
- Professional special tools



For more information visit our medias page.

Quick and efficient mounting support worldwide using augmented reality

As part of our new remote mounting service, we are able to support you with your rolling bearing maintenance and repair work, anywhere in the world. The use of augmented reality glasses enables us to provide concrete instructions – without us having to be on site. Especially in times of corona and the associated contact restrictions, this usually represents a faster solution that is cost-efficient at the same time.

We have a worldwide reputation for providing professional mounting services for rolling bearings. This service is now also available digitally and around the clock under the name Schaeffler Virtual Fitter. We use augmented reality (AR) technology for this purpose.

Remote mounting service – simple and fast

Now you're probably asking yourself, how does this work? It's quite simple, actually. If necessary, Schaeffler will immediately send you AR glasses as a rental device. You wear these during the machine check while a Schaeffler fitter is connected via a secure data connection. The live transmission of photos and videos provides him or her with a comprehensive picture of the machine status. Together with you and, if need be, a Schaeffler expert on site, the mounting work agreed upon in advance is carried out with our guidance. All steps are documented and transmitted to you thereafter.



Schaeffler Virtual Fitter – We support you live during assembly work without being on site in person

Save time and money – cost reductions of up to 50 percent

Our remote mounting service is usually available more quickly than an on-site Schaeffler expert would be, who would have to travel there in person. Plus, this time advantage saves hard cash because travel and personnel expenses are reduced and, in many cases, the costs associated with machine downtime are lower too. "Compared to on-site service, our customers save up to 50 percent of costs by using the remote service. In addition, the expert instructions also transfer know-how to the customer," says Reinhold Daft, Head of Mounting Services at Schaeffler.

Here's how it works – using the Virtual Fitter is straightforward

When you request a mounting service from us, you will now receive two quotes that will allow you to compare the costs of a personal service call on site with the remote mounting service. Before the actual service takes place, we will discuss all aspects that are essential for the smooth and successful implementation of the work to be performed. Among other things, we will clarify whether and which special tools are required. Incidentally, we can usually provide these on loan as well.



We see the world through your eyes – Worldwide remote assembly support through virtual reality technology.

MAKE A CONTRIBUTION TO ENVIRONMENTAL PROTECTION! REMANUFACTURING REDUCES CO₂ EMISSIONS BY UP TO 95 %.



Extend the operating life time of your medium and large rolling bearings and have them reconditioned.

Advantages

- Saves material and energy costs
- Lowers life cycle costs (LCC)
- Reduces inventory costs thanks to lower procurement prices
- Considerable flexibility due to short delivery times
- Almost identical warranty as for new products
- Same quality requirements for components and new parts

Cost efficiency

The characteristics and condition of rolling bearings have a significant influence on the production process. Consistently high availability can be achieved through preventive and condition-based maintenance. Frequently, new rolling bearings are fitted, although the existing bearings could be returned to an as-new condition by means of expert reconditioning. In many cases, it is more cost effective to recondition used rolling bearings than to install new ones.



Rollers and raceway with corrosion marks and foreign body indentations



Reground raceway, new rollers with adjusted oversize

Reconditioning Levels

The operations necessary in reconditioning are dependent on the condition of the rolling bearing. In order to allow a reliable statement of the work required, the rolling bearing must be disassembled, cleaned and then carefully examined. Beyond this requalifying process (Level I), which is always necessary, further reconditioning steps may be appropriate:

Dimensions

Reconditioning and modification can be carried out on all rolling bearings with an outside diameter D from 100 mm to 4500 mm. In the case of rolling bearings with an outside diameter larger than 4500 mm, please contact us. The team of experts at Schaeffler can offer comprehensive advice.

Once total costs are taken into consideration (TCO = Total Cost of Ownership), reconditioning is only feasible in technical terms at or above a certain outside diameter, see table.

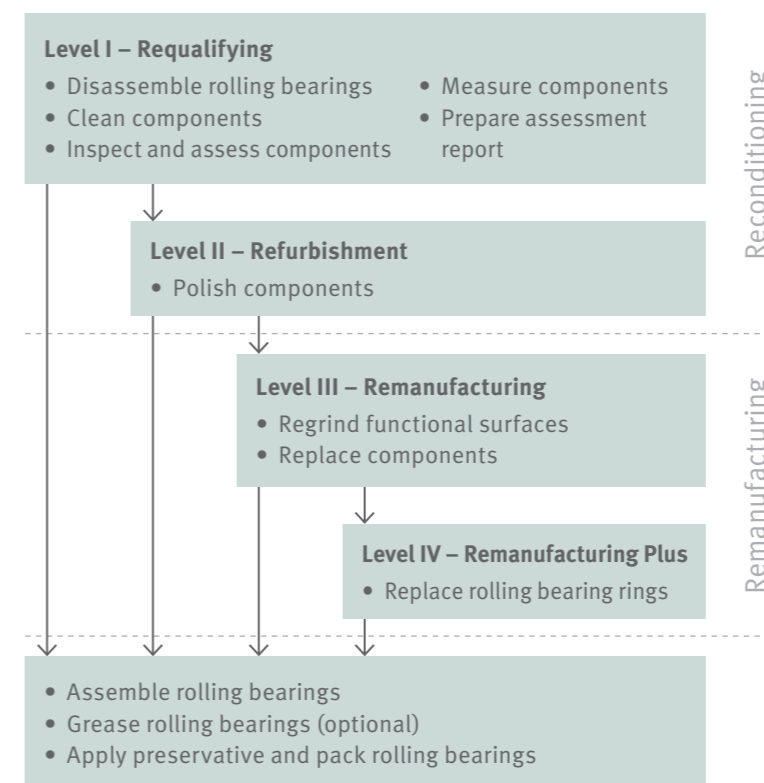

For more information visit our medias page.

Schaeffler Technologies AG & Co. KG

Georg-Schäfer-Strasse 30
97421 Schweinfurt
Germany
www.schaeffler.com
info@schaeffler.com

In Germany:
Phone 0180 5003872
From other countries:
Phone +49 9721 91-0

Every care has been taken to ensure the correctness of the information contained in this publication but no liability can be accepted for any errors or omissions. We reserve the right to make technical changes.

© Schaeffler Technologies AG & Co. KG
Issued: 2022, October
This publication or parts thereof may not be reproduced without our permission.